

Fiat Dukato XL:

«D» d18
d11 «D»

d18

«A»

«B».

! «A»

10

10 1,25 35.

10 35

« » «D»

Закрепите кронштейны перекладины «G», «H» ().

Установите левый и правый уголки, закрепив их сначала «J» .

«N» .

Момент затяжки	
M6	9,5 Nm
M8	23 Nm
M10	46 Nm
M12	79 Nm
M14	125 Nm
M16	195 Nm
M10x1,25	49 Nm
M12x1,25	87 Nm
M12x1,5	83 Nm

462800,

« - »

18

:: (35363) 7-05-06

/ : (35363) 7-13-20

(495) 799-13-46

www.bosal-autoflex.ru

www.bosal.com

info@bosal-autoflex.ru

	1	1	- .
	12 40	3	.
	12 50	2	.
	12 60	1	.
	12 130	2	.
	16 50	2	.
	10 35	8	.
	10 35 1,25	4	.
	8 25	6	.
	6 16	2	.
	16 /	2	.
	12 /	4	.
	10 /	4	.
	8 /	2	.
	6 /	2	.
	16	4	.
	12	4	.
	12	2	.
	12	10	.
	10	12	.
	10	4	.
	8	4	.
	8	4	.
	8	4	.
	6	4	.
		1	.
		1	.
	12	2	.
	12 (40 40 8)	2	.
		2	.
	L=92	2	.
	F	1	.
		1	.
		1	.

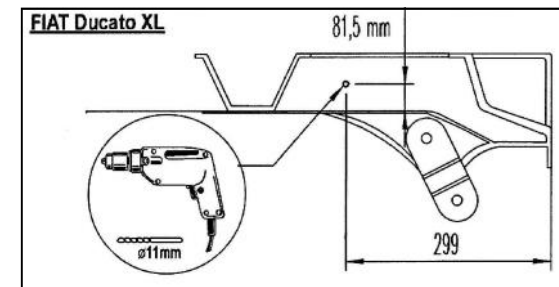
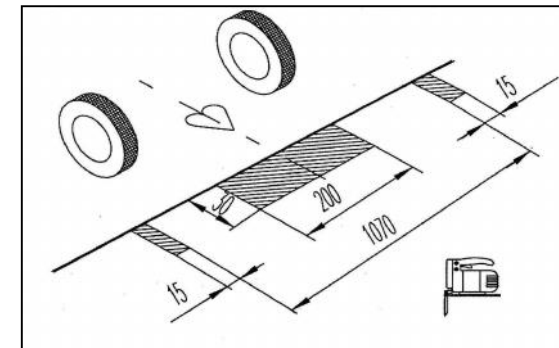











	1	.
	1	.
	1	.
	1	.
	1	.
	1	.

..... :

..... VIN

.....

bosal

	26 34 F Fiat Ducato Fiat Ducato XL Peugeot Boxer 3 Citroen Jumper  2006 ⇨	 		 	 		D	
			4000	2000	100	29.1	13,07 kN.	Bosal Autoflex Russia BAR 28

bosal

